

EDELHOLZPROFILE PROFILS EN BOIS PRÉCIEUX

**ST+K**  
STAHEL+KÖNG AG



<b>HOLZARTEN</b> BOIS	<b>01</b>
<b>RAHMEN</b> CADRES	<b>02</b>
<b>FICHTE WEISS LASIERT</b> ÉPICÉA TEINTÉ BLANC	<b>03</b>
<b>FLACHPROFILE</b> PROFILS PLATS	<b>04</b>
<b>KÄSTCHENPROFILE/DISTANZLEISTEN</b> PROFILS HAUTS/BAGUETTES DE DISTANCE	<b>05</b>
<b>KÄSTCHENPROFILE/DISTANZLEISTEN</b> PROFILS HAUTS/BAGUETTES DE DISTANCE	<b>06</b>
<b>KÄSTCHENPROFILE</b> PROFILS HAUTS	<b>07</b>
<b>DISTANZLEISTEN/GERUNDETE PROFILE</b> BAGUETTES DE DISTANCE/PROFILS ARRONDIS	<b>08</b>
<b>FICHTE/ANHÄNGELEISTEN «PLUS»</b> ÉPICÉA/BAGUETTES D'ACCROCHAGE «PLUS»	<b>09</b>
<b>L-PROFILE</b> CAISSES AMÉRICAINES	<b>10</b>
<b>L-PROFILE</b> CAISSES AMÉRICAINES	<b>11</b>
<b>KEILRAHMEN</b> CHÂSSIS	<b>12</b>
<b>VERKAUS- UND LIEFERBEDINGUNGEN</b> CONDITIONS DE VENTE ET DE LIVRAISON	<b>13</b>



Ahorn Érable **AH**



Birnbaum Poirier **BI**



Mahagoni Acajou **MA**



Eiche Chêne **EI**



Esche Frêne **ES**



Fichte Épicéa **FI**



Kirschbaum Cerisier **KI**



Linde Tilleul **LI**



Weymouth hell Weymouth non abouté **HE**

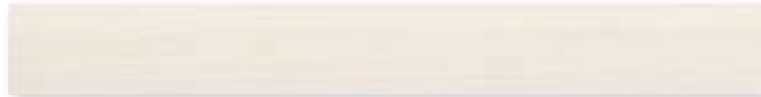

weiss lasiert teinté blanc

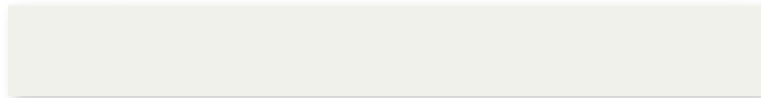

weiss matt lackiert verni blanc mat



schwarz matt lackiert verni noir mat



#### Preis für Zuschnitte und Rahmen (nur Arbeit)

halber Umfang	bis 160 cm	bis 250 cm
Zuschnitt	15.00	25.00
Leerrahmen verleimt (Naturholz)	28.00	56.00
Rahmen verleimt, über Eck lackiert (weiss stumpfmatt, schwarz stumpfmatt, natur, weiss lasiert)	88.00	141.00
Rahmen natur matt geölt	45.00	65.00

halber Umfang über 250 cm: Preis auf Anfrage

#### Mengenrabatte

Stück		
2	10%	10%
5	20%	20%
10	30%	30%
20	40%	40%

#### Prix pour cadres coupés à l'onglet ou assemblés (uniquement travail)

demi-périmètre	jusqu'à 160 cm	jusqu'à 250 cm
cadre coupé à l'onglet	15.00	25.00
cadre vide assemblé (bois brut)	28.00	56.00
cadre assemblé, verni coins couverts (verni blanc mat, noir mat, naturel ou teinté blanc)	88.00	141.00
cadre huilé mat	45.00	65.00

demi-périmètre plus de 250 cm: prix sur demande

#### Rabais de quantité

pièces		
2	10%	10%
5	20%	20%
10	30%	30%
20	40%	40%



Sichtbare Eckverbindung mit zwei Einsätzen  
Assemblage angulaire visible avec deux pièces de jonction par angle



Sichtbare Eckverbindung mit drei Einsätzen  
Assemblage angulaire visible avec trois pièces de jonction par angle

**Zusatz**

Eckverbindung sichtbar verstärkt	Pro Rahmen
mit je 2 Einsätzen pro Rahmenecke	15.00
mit je 3 Einsätzen pro Rahmenecke	30.00
mit je 4 Einsätzen pro Rahmenecke	40.00

**Eckverbindungen unsichtbar verstärkt**

Eckverbindung Lamello	12.00
-----------------------	-------

**Plus-value**

Assemblage angulaire visible	par cadre
avec 2 pièces de jonction par angle	15.00
avec 3 pièces de jonction par angle	30.00
avec 4 pièces de jonction par angle	40.00

**Assemblage renforcé non visible**

Assemblage angulaire Lamello	12.00
------------------------------	-------

FICHTE WEISS LASIERT ÉPICÉA TEINTÉ BLANC

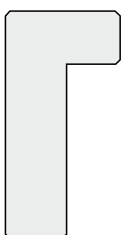

15.1828.30. FIW **6.20**

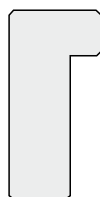

12.1829.25. FIW **5.20**



20.1828.15. FIW **5.55**



25.1828.15. FIW **6.05**



30.1828.15. FIW **6.45**



6.5200.15. FIW **4.05**



3.5200.10. FIW **2.90**





8.1200.11. HE



10.1200.11. AH  
10.1200.11. BI  
10.1200.11. HE  
10.1200.11. KI



12.1200.11. AH  
12.1200.11. EI  
12.1200.11. HE  
12.1200.11. KI

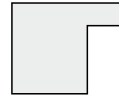

15.1200.12. AH  
15.1200.12. BI  
15.1200.12. EI  
15.1200.12. HE

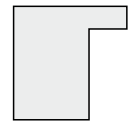

15.1200.15. AH  
15.1200.15. EI  
15.1200.15. HE  
15.1200.15. LI

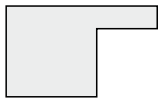

20.1200.12. AH  
20.1200.12. EI  
20.1200.12. HE  
20.1200.12. LI

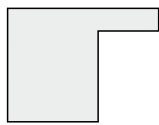

20.1200.15. AH  
20.1200.15. EI  
20.1200.15. HE  
20.1200.15. LI

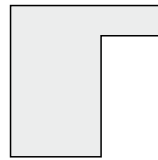

20.1200.20. AH  
20.1200.20. EI  
20.1200.20. HE  
20.1200.20. KI  
20.1200.20. LI

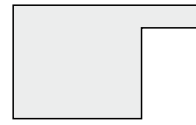

25.1200.15. AH  
25.1200.15. EI  
25.1200.15. HE  
25.1200.15. LI

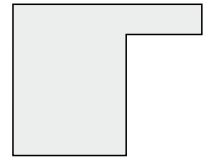

25.1200.20. AH  
25.1200.20. EI  
25.1200.20. LI

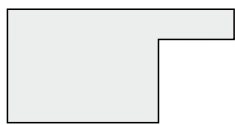

30.1200.15. AH  
30.1200.15. EI  
30.1200.15. HE  
30.1200.15. LI

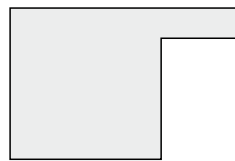

30.1200.20. AH  
30.1200.20. EI  
30.1200.20. LI

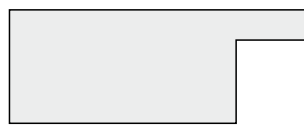

40.1200.15. AH  
40.1200.15. EI  
40.1200.15. HE  
40.1200.15. LI

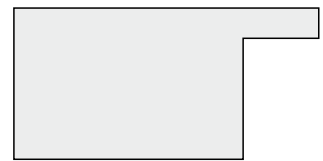

40.1200.20. EI  
40.1200.20. LI



50.1200.20. LI

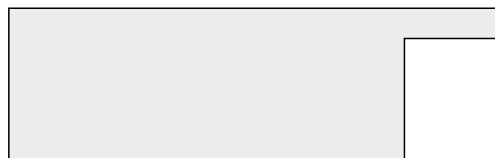

65.1200.20. EI  
65.1200.20. LI



8.1815.25. AH  
8.1815.25. HE  
8.1815.25. LI

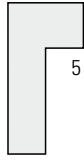

10.1820.20. AH  
10.1820.20. EI  
10.1820.20. HE  
10.1820.20. LI

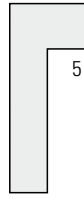

10.1820.25. AH  
10.1820.25. EI  
10.1820.25. HE  
10.1820.25. LI



10.1820.30. AH  
10.1820.30. EI  
10.1820.30. HE  
10.1820.30. LI  
10.1820.30. MA



10.1820.40. AH  
10.1820.40. EI  
10.1820.40. HE  
10.1820.40. LI

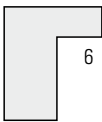

12.1820.15. AH  
12.1820.15. EI  
12.1820.15. HE  
12.1820.15. LI

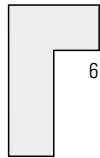

12.1820.20. AH  
12.1820.20. EI  
12.1820.20. HE  
12.1820.20. LI

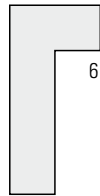

12.1820.25. AH  
12.1820.25. BI  
12.1820.25. EI  
12.1820.25. ES  
12.1820.25. HE  
12.1820.25. LI  
12.1820.25. MA



12.1820.30. AH  
12.1820.30. EI  
12.1820.30. HE  
12.1820.30. LI



12.1820.40. AH  
12.1820.40. HE  
12.1820.40. LI  
12.1820.40. EI

DISTANZLEISTEN BAGUETTES DE DISTANCE



3.5200.4. AH  
3.5200.4. HE  
3.5200.4. LI



4.5200.6. AH  
4.5200.6. EI  
4.5200.6. HE  
4.5200.6. LI



4.5200.10. AH  
4.5200.10. EI  
4.5200.10. HE  
4.5200.10. LI  
4.5200.10. MA



4.5200.15. AH  
4.5200.15. EI  
4.5200.15. HE  
4.5200.15. LI



5.5200.10. AH  
5.5200.10. BI  
5.5200.10. EI  
5.5200.10. HE  
5.5200.10. LI  
5.5200.10. MA



5.5200.15. AH  
5.5200.15. EI  
5.5200.15. HE  
5.5200.15. LI



5.5200.20. AH  
5.5200.20. EI  
5.5200.20. HE  
5.5200.20. LI

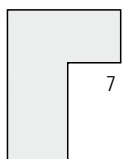

15.1825.20. AH  
15.1825.20. EI  
15.1825.20. HE  
15.1825.20. LI

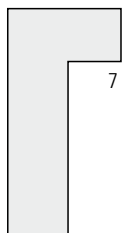

15.1825.30. AH  
15.1825.30. EI  
15.1825.30. ES  
15.1825.30. HE  
15.1825.30. LI  
15.1825.30. MA



15.1825.35. AH  
15.1825.35. EI  
15.1825.35. HE  
15.1825.35. LI

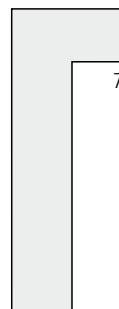

15.1825.40. AH  
15.1825.40. EI  
15.1825.40. HE  
15.1825.40. LI

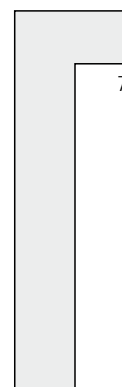

15.1825.50. AH  
15.1825.50. EI  
15.1825.50. HE  
15.1825.50. LI

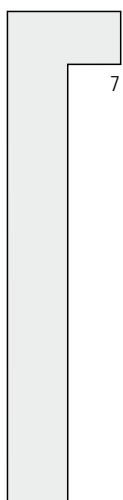

15.1825.65. HE

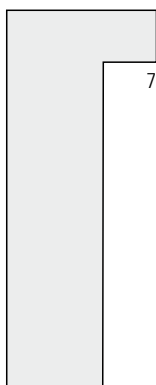

20.1825.50. LI

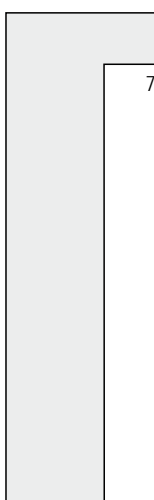

20.1825.65. LI

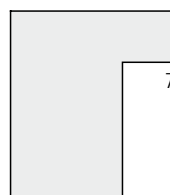

22.1825.25. HE

DISTANZLEISTEN BAGUETTES DE DISTANCE



6.5200.5. AH



6.5200.8. HE



6.5200.10. AH  
6.5200.10. EI  
6.5200.10. ES  
6.5200.10. HE  
6.5200.10. LI  
6.5200.10. MA



6.5200.15. AH  
6.5200.15. EI  
6.5200.15. ES  
6.5200.15. HE  
6.5200.15. LI



6.5200.20. AH  
6.5200.20. EI  
6.5200.20. HE  
6.5200.20. LI



6.5200.30. AH  
6.5200.30. EI  
6.5200.30. HE  
6.5200.30. LI



6.5200.40. HE  
6.5200.40. LI

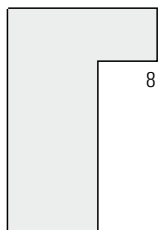

20.1205.30. AH  
20.1205.30. EI  
20.1205.30. ES  
20.1205.30. HE  
20.1205.30. LI  
20.1205.30. MA

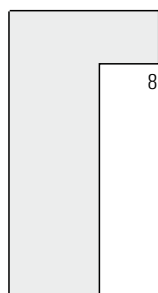

20.1205.38. HE  
20.1205.38. LI

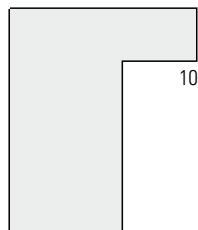

25.1205.30. HE  
25.1205.30. LI

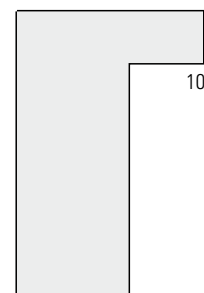

25.1205.38. HE  
25.1205.38. LI

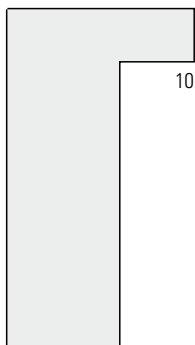

25.1205.45. EI  
25.1205.45. ES  
25.1205.45. HE  
25.1205.45. LI

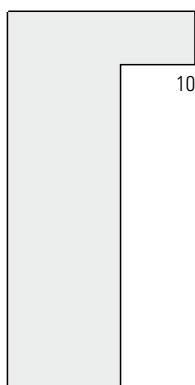

25.1205.50. ES  
25.1205.50. LI  
25.1205.50. MA

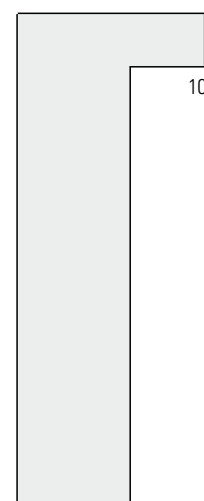

25.1205.65. LI

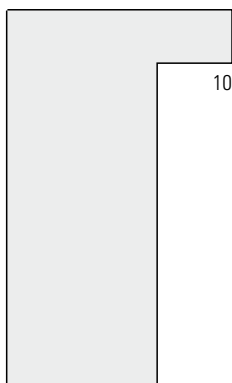

30.1205.50. LI

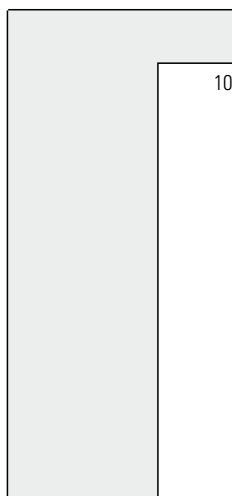

30.1205.65. ES  
30.1205.65. FI  
30.1205.65. LI

mit Überlänge bis ca. 4000 mm } +25% Mehrpreis  
sur demande jusqu'à 4000 mm env. } +25% de supplément



7.5200.12. HE



7.5200.15. AH  
7.5200.15. EI  
7.5200.15. ES  
7.5200.15. HE  
7.5200.15. LI  
7.5200.15. MA



7.5200.20. HE  
7.5200.20. LI



7.5200.30. HE  
7.5200.30. LI



9.5200.10. HE  
9.5200.10. LI



9.5200.15. HE  
9.5200.15. LI

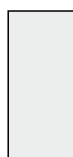

9.5200.20. HE  
9.5200.20. LI

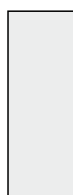

9.5200.25. EI  
9.5200.25. ES  
9.5200.25. HE  
9.5200.25. LI  
9.5200.25. MA



9.5200.30. LI



9.5200.40. ES  
9.5200.40. FI  
9.5200.40. LI

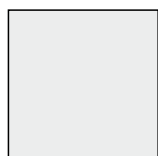

20.5200.20. FI

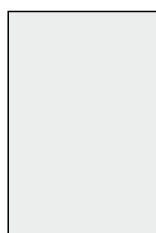

20.5200.30. FI

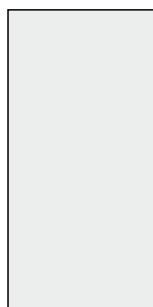

20.5200.40. FI

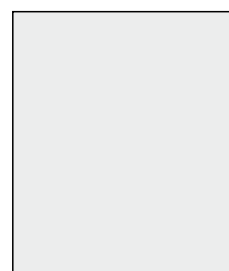

30.5200.35. FI

GERUNDETE PROFILE PROFILS ARRONDIS

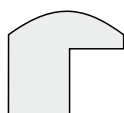

15.1605.14. HE



20.1605.14. HE

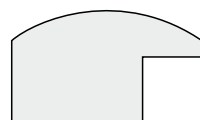

25.1605.15. HE

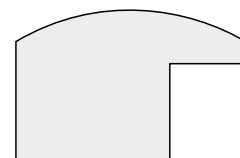

30.1605.20. HE



18.1616.15. LI

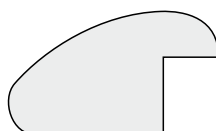

27.1616.16. LI

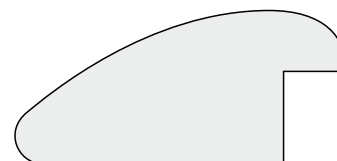

43.1616.20. LI



10.1829.25. FI

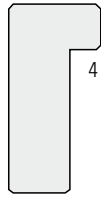

12.1829.25. FI

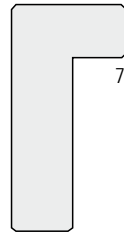

15.1828.30. FI

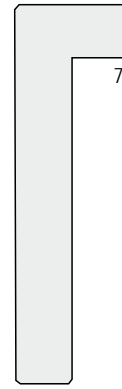

15.1828.50. FI

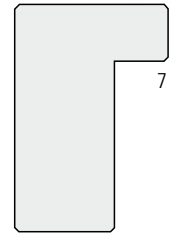

20.1828.30. FI

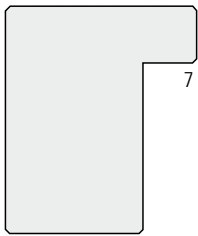

25.1828.30. FI



3.5200.10. FI



4.5200.10. FI



5.5200.6. FI



6.5200.15. FI



6.5200.35. FI

AUFHÄNGELEISTEN «PLUS» BAGUETTES D'ACCROCHAGE «PLUS»



8.5210.20.



8.5210.40.



10.5210.20.

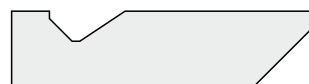

10.5210.40.

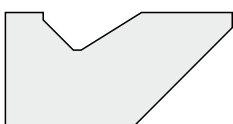

15.5210.30. BU



10.5210.50.

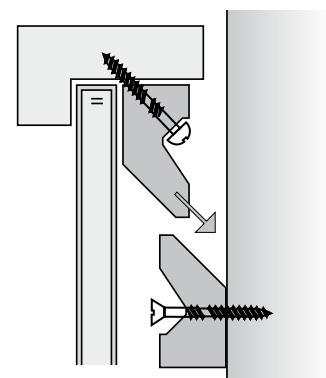
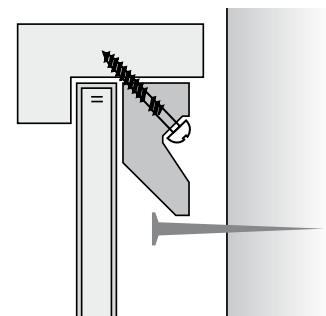

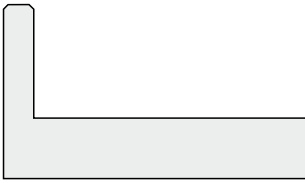

40.2215.23. FI  
40.2215.23. LI

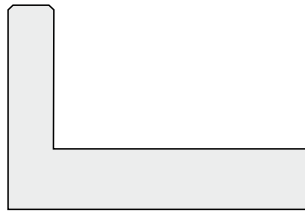

40.2215.27. FI  
40.2215.27. LI

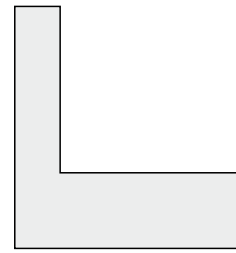

30.2202.32. AH  
30.2202.32. EI  
30.2202.32. ES  
30.2202.32. FI  
30.2202.32. HE  
30.2202.32. LI  
30.2202.32. MA

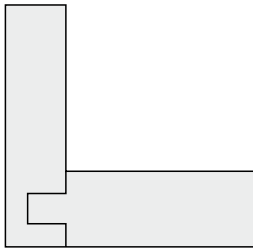

33.2203.32. AH  
33.2203.32. EI  
33.2203.32. FI  
33.2203.32. HE  
33.2203.32. LI  
33.2203.32. MA

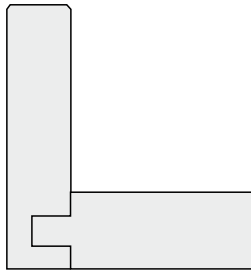

33.2215.35. AH  
33.2215.35. EI

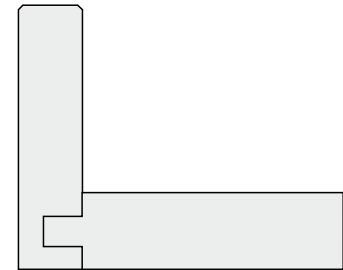

43.2215.35. FI  
43.2215.35. HE  
43.2215.35. LI

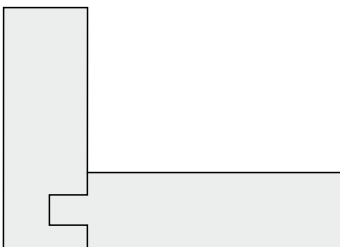

45.2201.32. AH  
45.2201.32. EI  
45.2201.32. FI  
45.2201.32. HE  
45.2201.32. LI

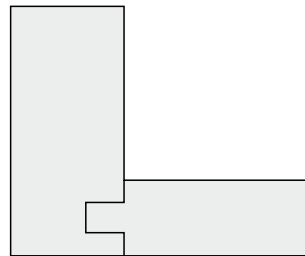

40.2205.33. AH  
40.2205.33. EI  
40.2205.33. ES  
40.2205.33. HE  
40.2205.33. LI  
40.2205.33. MA

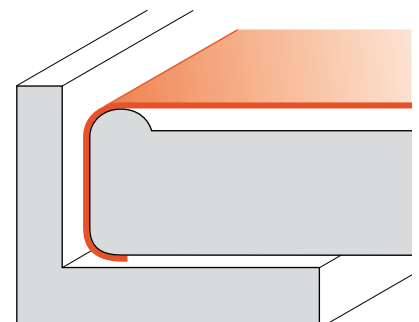
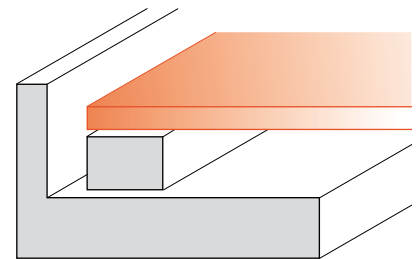

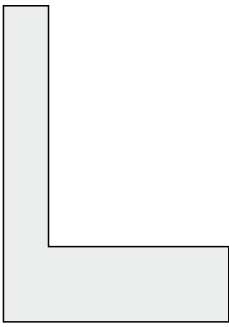

30.2202.42. FI  
30.2202.42. HE  
30.2202.42. LI

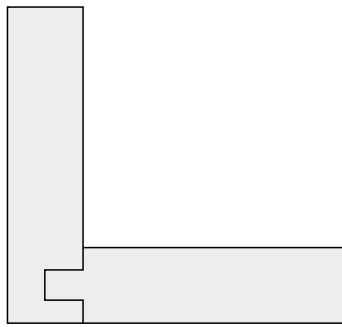

45.2201.42. FI  
45.2201.42. HE

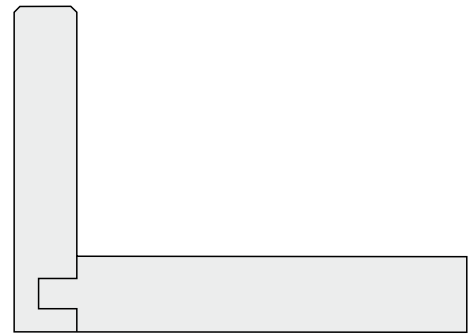

60.2215.43. FI  
60.2215.43. LI

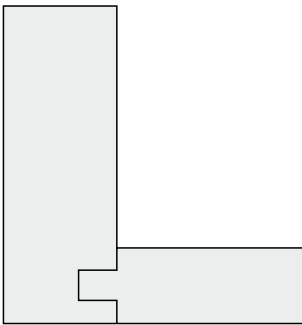

40.2205.42. HE

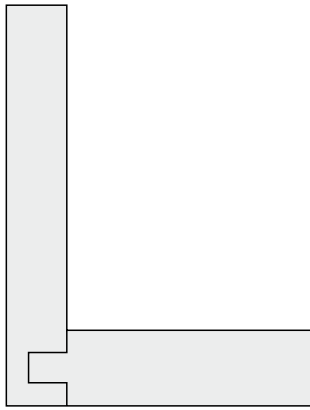

41.2203.53. FI  
41.2203.53. HE  
41.2203.53. LI

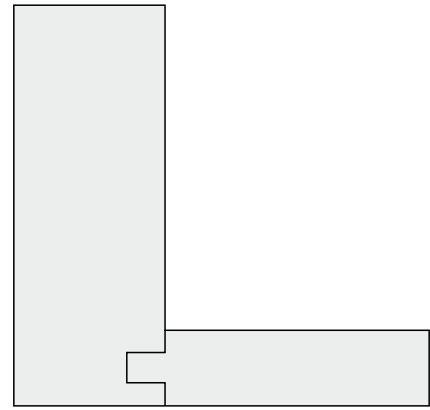

55.2210.53. FI  
55.2210.53. HE  
55.2210.53. LI

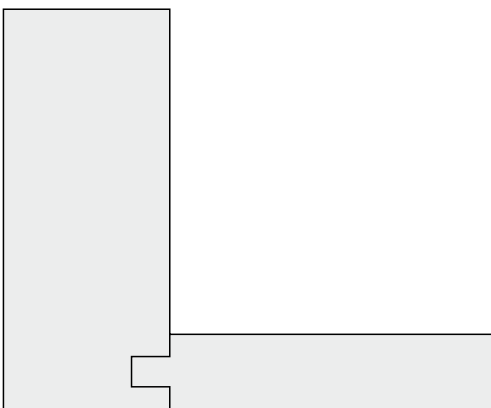

65.2230.53. LI  
mit Überlänge bis ca.  
4000 mm  
sur demande jusqu'à  
4000 mm env. } +25% Mehrpreis  
de supplément

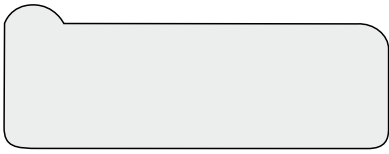

50.6000.19. K

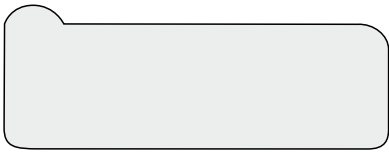

50.6000.19.

Laufmeter (nicht zugeschnitten)  
mètre linéaire (pas coupé à l'onglet)

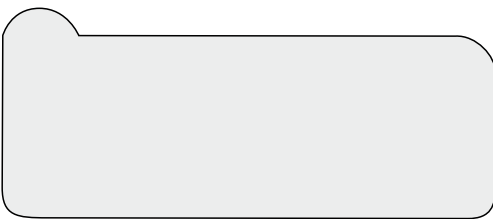

64.6000.28. K

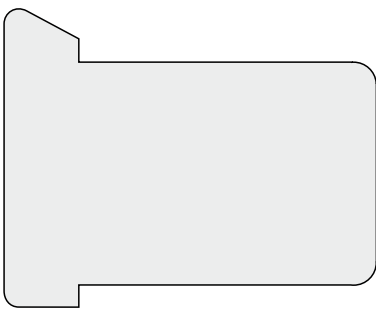

49.6000.39. K

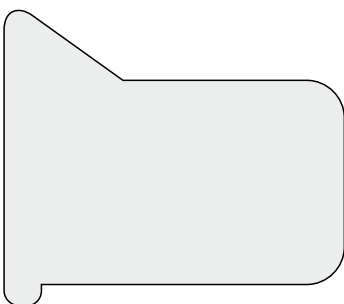

45.6000.39. K

**Top Qualität:**

Espenholz – keilverzinkt und lamelliert  
Aus vorbildlicher Waldwirtschaft

**Top qualité:**

Tremble –abouté et lamellé  
Provenance de forêts bien gérées

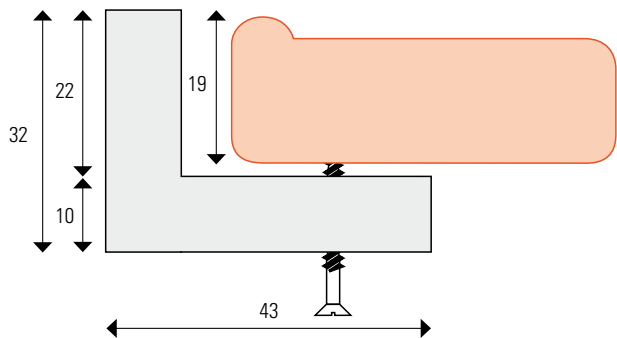

Breite – largeur – 43 2200. 32 – Höhe – hauteur

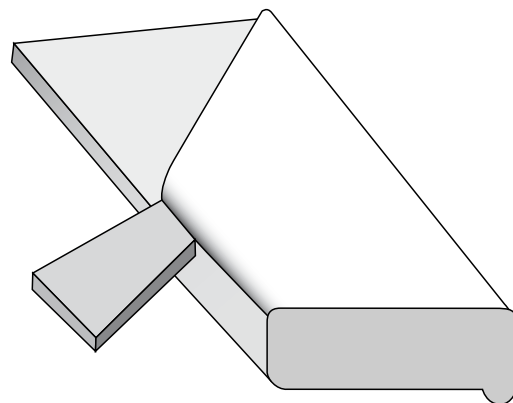

Preise pro Laufmeter, Keile inbegriffen  
Kreuz 11.95 (Zuschlag für Arbeit)

Prix par ml, clés inclus  
Coix 11.95 (plusvalue)

**Ausführungsvarianten**

Die übliche Stablänge liegt zwischen 2 und 3 m, Überlängen bis 4 m. Alle Stäbe sind ungezinkt und unverleimt.

**Spezialanfertigungen**

Auf Wunsch können wir alle gängigen Holz- und Profilarten liefern. Geringe Farb- und Strukturunterschiede des Holzes, wie z.B. Spiegel bei Eiche oder Riegel bei Ahorn, sind naturgegeben und zu akzeptieren. Bei Zuschnitten wählen wir möglichst homogene Schenkel.

**Preise**

Die Preise gelten je Laufmeter, ab Werk, exkl. MWST. Spezialanfertigungen in anderen Holzarten oder Profilformen auf Anfrage.

**Mengenrabatte für Rahmen und Zuschnitte**

2 Stück	10%
5 Stück	20%
10 Stück	30%
20 Stück	40%

**Mengenrabatte für Lagerprofile**

ab 12 lfm	3%
ab 24 lfm	6%
ab 60 lfm	12%
ab 150 lfm	16%

**Verpackungs- und Frachtkostenanteil**

bis 175 cm Länge, bis 10 kg: CHF 15.–  
 über 175 cm Länge, bis 30 kg: CHF 25.–  
 Bestellungen unter CHF 50.–: CHF 25.–  
 Express-Aufträge und Pakete über 30 kg werden nach anfallenden Kosten verrechnet.

**Beanstandungen**

Bis spätestens 10 Tage nach Erhalt der Lieferung.

**Mindestbezugsmenge**

Lagerprofile 6 m je Sorte.

**Mindestwarenwert**

CHF 50.–

**Zahlungskonditionen**

30 Tage, rein netto.

**Aufbau der Profilbezeichnung**

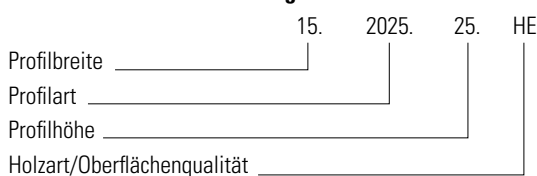

**Types d'exécution**

La longueur standard des baguettes est de 2 à 3 m, certains profils indiqués jusqu'à 4m. Toutes les baguettes ne sont pas dentelées (non abouté).

**Fabrication sur mesure**

Sur simple demande, nous pouvons vous fournir tous genres de bois habituels et chaque type de profil. Des différence de teinte naturelles devront être acceptées. Pour la coupe à l'onglet, nous sélectionnons les baguettes le plus possible selon des structures homogènes.

**Prix**

Les prix s'entendent mètre linéaire, à partir de l'usine. T.V.A. excluse. Toute fabrication spéciale dans un bois ou un profil différent sur demande.

**Rabais de quantité pour cadres vides assemblés ou coupés à l'onglet**

2 pièces	10%
5 pièces	20%
10 pièces	30%
20 pièces	40%

**Rabais de quantité pour profils en stock**

dès 12 m	3%
dès 24 m	6%
dès 60 m	12%
dès 150 m	16%

**Frais de livraison et d'emballage**

Envoi jusqu'à une longueur de 175 cm et 10 kg: CHF 15.–  
 Livraison d'une longueur de plus de 175 cm, jusqu'à 30 kg: CHF 25.–  
 Commandes d'une valeur inférieure à CHF 50.–: CHF 25.–  
 Les commandes «express» et les paquets de plus de 30 kg seront facturés selon les frais se présentant réellement.

**Réclamations**

Les réclamations ne seront acceptées que 10 jours après réception de la livraison au plus tard.

**Quantité minimum de livraison**

Profils en stock, 6 m par type de profil.

**Montant minimum de facturation**

CHF 50.–

**Conditions de paiement**

Net à 30 jours.

**Structure des numéros des profils**

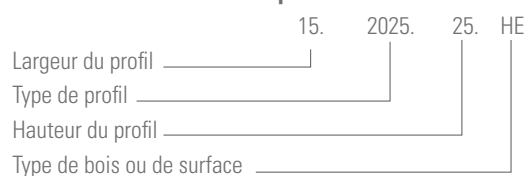



Stahel + Köng AG  
Kemptnerstrasse 13  
Postfach 396  
CH-8340 Hinwil  
Telefon +41 44 938 30 90  
Telefax +41 44 937 48 39  
E-Mail [info@st-k.ch](mailto:info@st-k.ch)  
[www.st-k.ch](http://www.st-k.ch)

